

Senso 3674 Complete set, for two-piece flaps made of wood or with aluminium frame



Flap made of wood

- Material: Fitting: Steel, aluminium, cover cap: Plastic
- Finish: Fitting: Silver coloured anodized, cover cap: Grey, similar to RAL 9006
- Screw-on brackets for wood supplied

Adjustment facility

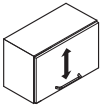

Height adjustment
±3 mm

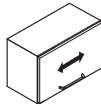

Side adjustment
±3 mm



Holding power
adjustment

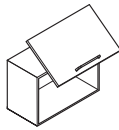

Opening angle
adjustment

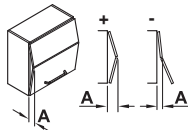

Centre pull
adjustment

Installation

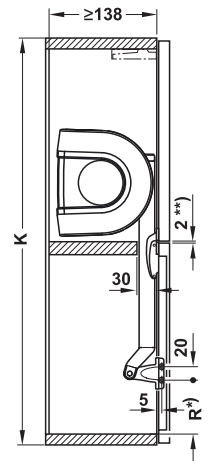
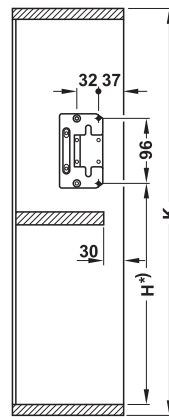
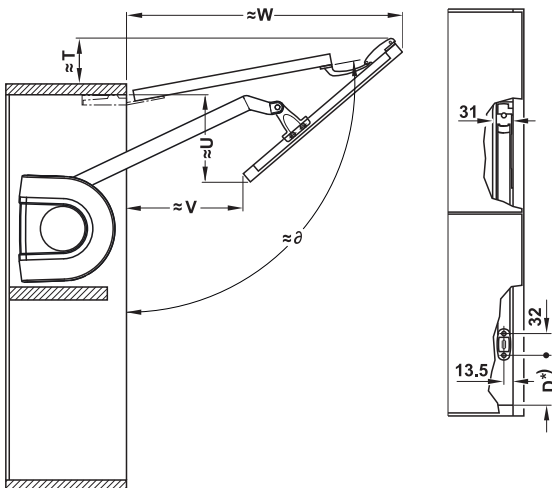

Installation dimensions

Flap height mm	δ	D	H	R	T	U	V	W
550	101°	57.5	290	63.5	70	139	192	390
600	101°	73.5	326	79.5	70	130	170	405
650	103°	67.5	340	73.5	95	160	220	425
720	102°	75.5	378	81.5	96	207	261	456
800	100°	71.5	392	77.5	85	255	260	500
865	102°	47.5	400	53.5	120	260	315	525

Supplied with

- 1 Double flap lift up fitting
- 2 Screw-on brackets for wooden flaps or flaps with aluminium frame, from frame width 45 mm
- 1 Set of installation instructions

Flap height mm	Flap weight kg	Cat. No.
550 (540 – 580)	3.0 – 6.5	372.64.601
	6.0 – 12.0	372.64.602
	9.0 – 18.0	372.64.603
	12.0 – 24.5	372.64.604
600 (580 – 640)	3.0 – 6.0	372.64.611
	6.0 – 11.0	372.64.612
	9.0 – 17.0	372.64.613
	12.0 – 23.0	372.64.614
650 (640 – 700)	3.0 – 5.5	372.64.621
	5.5 – 10.0	372.64.622
	8.0 – 16.0	372.64.623
	10.5 – 21.5	372.64.624
720 (700 – 780)	3.5 – 5.5	372.64.631
	5.0 – 9.0	372.64.632
	7.0 – 15.0	372.64.633
	9.0 – 20.0	372.64.634
800 (780 – 840)	5.0 – 9.0	372.64.642
	7.0 – 13.0	372.64.643
	9.0 – 17.0	372.64.644
865 (840 – 900)	5.5 – 12.0	372.64.653
	7.5 – 16.0	372.64.654

Packing: 1 set

Order reference

Screw-on brackets, adapters for 20 mm aluminium profiles and connecting hinge are not supplied. Please order separately. Special models with 2/3 and 1/3 flap heights possible on request.

→ Senso 3674 and E-Senso 3686 accessories

Screw-on bracket with round hole

For wooden flaps or flaps with aluminium frame, from frame width 45 mm

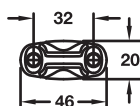
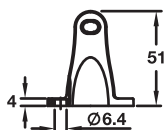

- Area of application: For mounting the double flap lift up fitting
- Material: Plastic

Finish	Cat. No.
Silver coloured, similar to RAL 9006	372.64.990

Packing: 1 or 10 pieces

Screw-on bracket with slot

For flaps with aluminium frame, frame width 20 mm

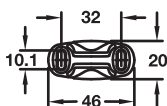
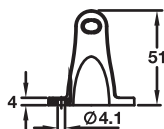

- Area of application: For mounting the double flap lift up fitting
- Material: Plastic

Colour	Cat. No.
Grey, similar to RAL 9006	372.64.991

Packing: 1 or 10 pieces

Order reference

Please order separately for aluminium frame
Cat. No. 372.64.995.

Adapter for aluminium profile

For screw fixing to screw-on bracket Cat. No. 372.64.991

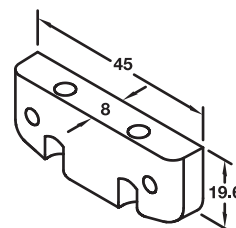

- Area of application: For right and left hand use
- Material: Zinc alloy

Drilling pattern

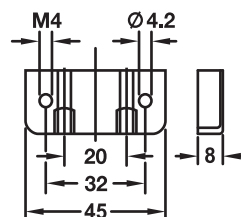

Finish	Cat. No.
Nickel plated	372.64.995

Packing: 1 or 10 pieces

Order reference

Please order screw-on bracket Cat. No. 372.64.991 separately.

Connecting hinge

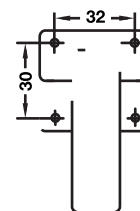

- Area of application: For wooden flaps and flaps with aluminium frame, from frame width 20 mm
- Material: Zinc alloy
- Finish: Nickel plated

Version	Function	Installation	Cat. No.
With guide pin	Not adjustable	With Varianta special screw	372.64.795
		With chipboard screws	372.64.790
Without guide pin	Not adjustable	With Varianta special screw	372.64.792
		With chipboard screws	372.64.793
	Adjustable	With Varianta special screw	372.64.794
Without guide pin	Adjustable	With chipboard screws	372.64.791

Packing: 1 or 10 pieces